



PRIME

Trustworthy
power

MASTERYS BC+

10 to 40 kVA



OBJECTIVES

The aim of these specifications is to provide:

- the information required to choose the correct uninterruptible power supply for a specific application.
- the information required to prepare the system and installation site.

The specifications are intended for:

- installation engineers.
- design engineers.
- engineering consultants.

INSTALLATION REQUIREMENTS AND PROTECTION

Connection to the mains power supply and load(s) must be implemented using cables of suitable size, in accordance with current standards. If not already present, an electrical control station which can isolate the network upstream of the UPS must be installed. This electrical control station must be equipped with a circuit breaker (or two, if there is a separate bypass line) of an appropriate rating for the power drawn at full load.

If an external manual bypass is required, only the model supplied by the manufacturer must be installed.

We recommend fitting two metres of unanchored flexible cable between the UPS terminals and the cable anchor (wall or cabinet). This makes it possible to move and service the UPS.

For detailed information, see the installation and operating manual.

1. ARCHITECTURE

1.1 RANGE

MASTERYS BC+ is a full range of high performing UPS designed to protect critical and sensitive appliances in “business critical” applications such as data servers.

Models								
Rated power (kVA)	10	15	20	10	15	20	30	40
	3/1			3/3				
MASTERYS BC+ B3 / M3	•	•	•	•	•	•		
MASTERYS BC+ S4							•	•
MASTERYS BC+ M4	•	•	•	•	•	•	•	•
MASTERYS BC+ FL	•	•	•	•	•	•	•	•

Matrix table for model and kVA power rating

Each family has been specifically designed to meet the demands of loads in specific application contexts, in order to optimise product features and facilitate integration within the system.

2. FLEXIBILITY

2.1 POWER RATINGS 10 TO 40 KVA

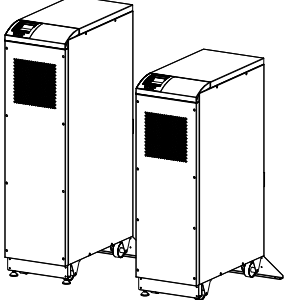
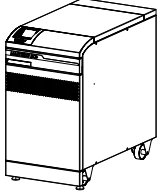
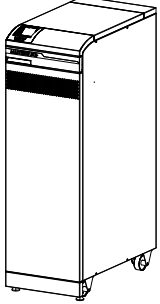
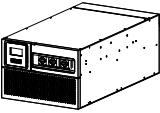
Dimensions				
Cabinet type		Width (W) [mm]	Depth (D) [mm]	Height (H) [mm]
	B3	370	770	1190
	M3	370	770	1375
	S4	444	800	800
	M4	444	800	1400
	FL	442	830	305

The equipment has been designed with a minimum direct and indirect footprint (the actual space occupied by the unit and the space required around it for maintenance, ventilation and access to operating mechanisms and communication devices).

All of the control mechanisms and communication interfaces are located in the upper front section and can be accessed from the first panel with the red surround (for B3 and M3, they are accessible from the back of the UPS).

The intelligent design also provides easy access for maintenance and installation.

The air inlet is on the front, with outflow to the rear.

2.2 PARALLEL

MASTERYS BC+ enables 2 configurations of UPS systems in the same range

MASTERYS BC+
10 to 40 kVA

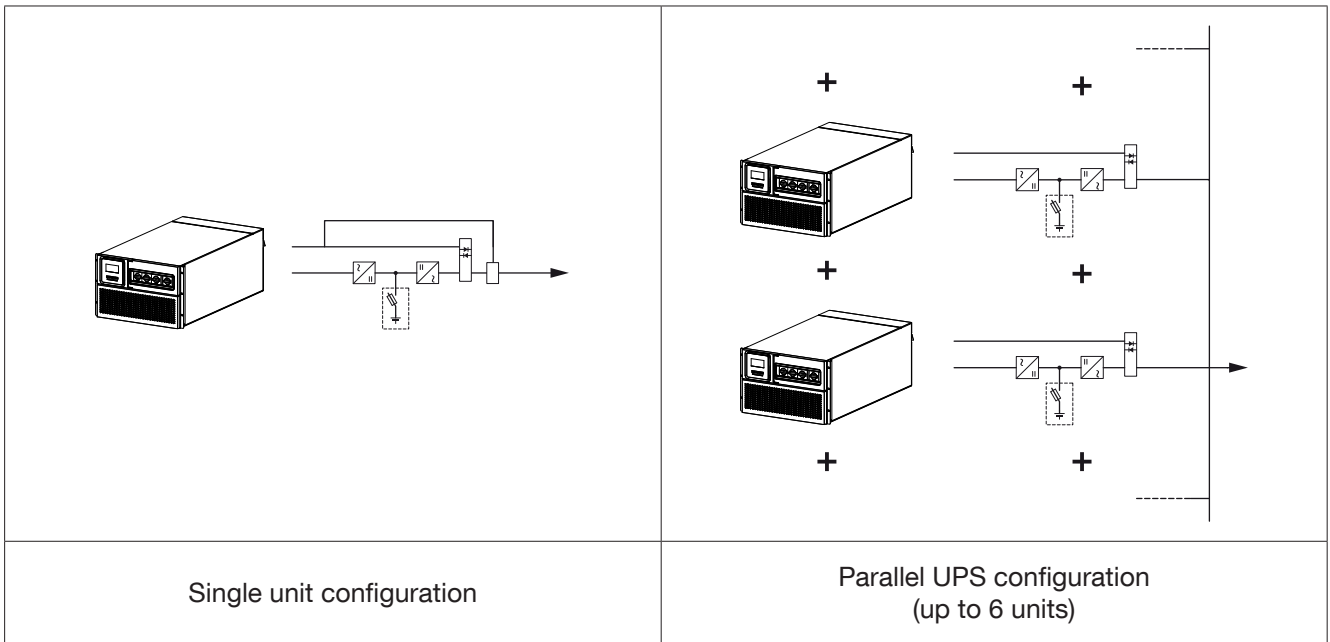
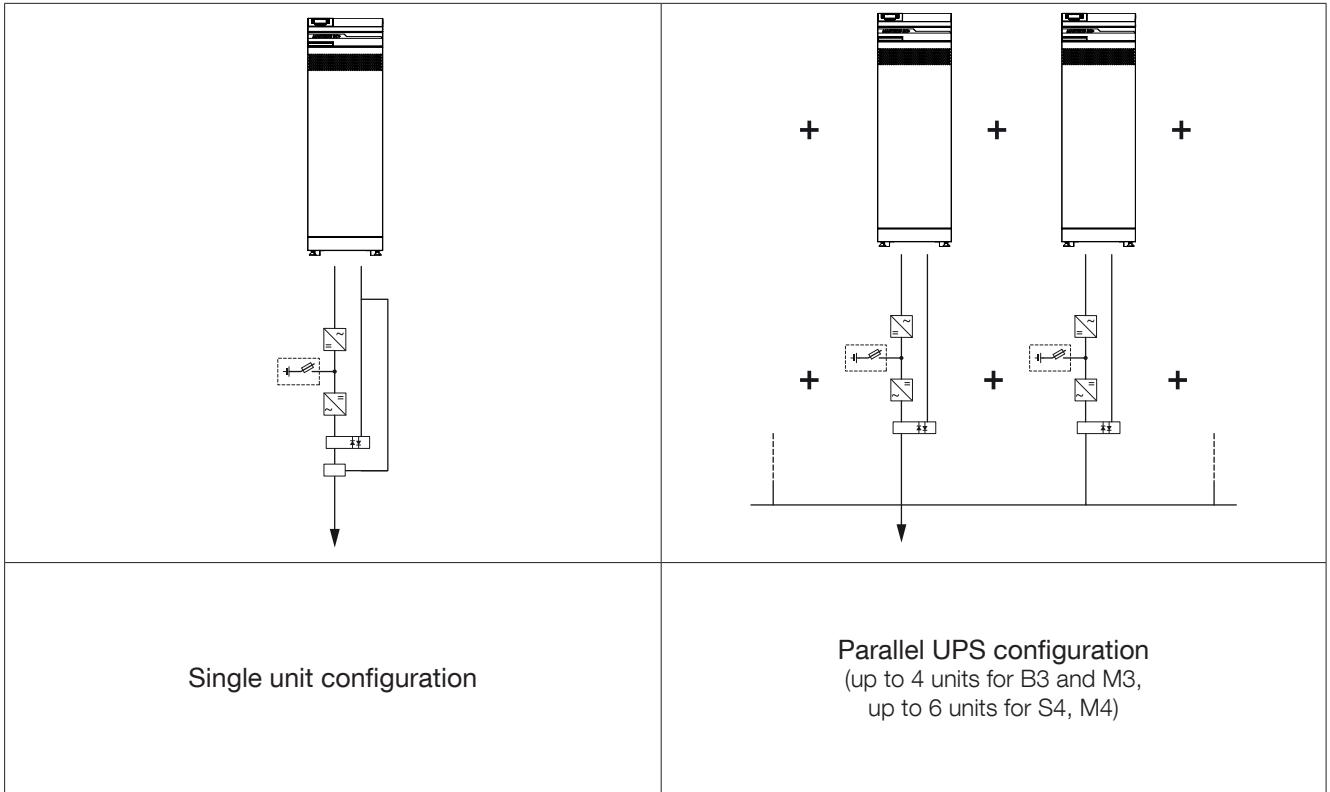

2.3 FLEXIBLE BACK-UP TIME

Different back-up times are possible by using models with internal battery or FLEX (FL) with external battery cabinets. Batteries are installed on acid-proof trays and connected by means of polarised connectors to facilitate their maintenance. To guarantee maximum back-up time availability and battery life, the MASTERYS BC+ 10-40 series is equipped with an EBS (Expert Battery System).

For external battery cabinets use model FL.

For internal batteries, use the following charts to select the model (B3, M3, S4 or M4) in relation to power and back-up time.

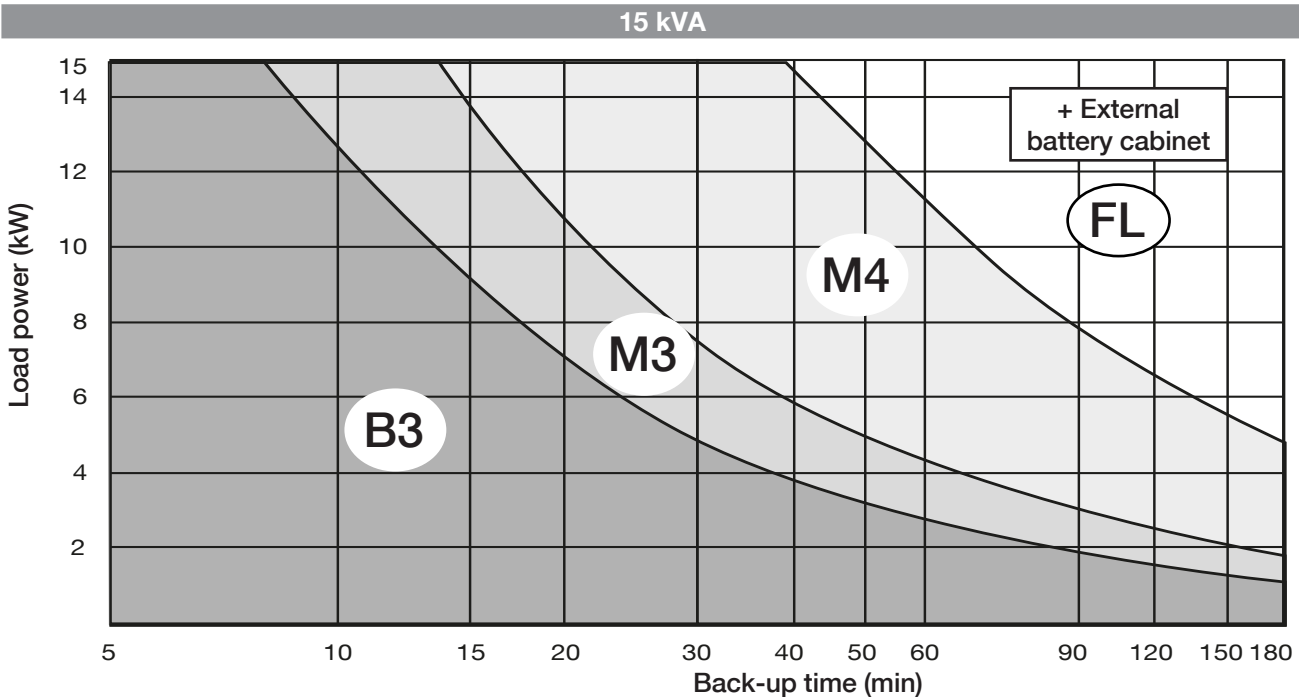
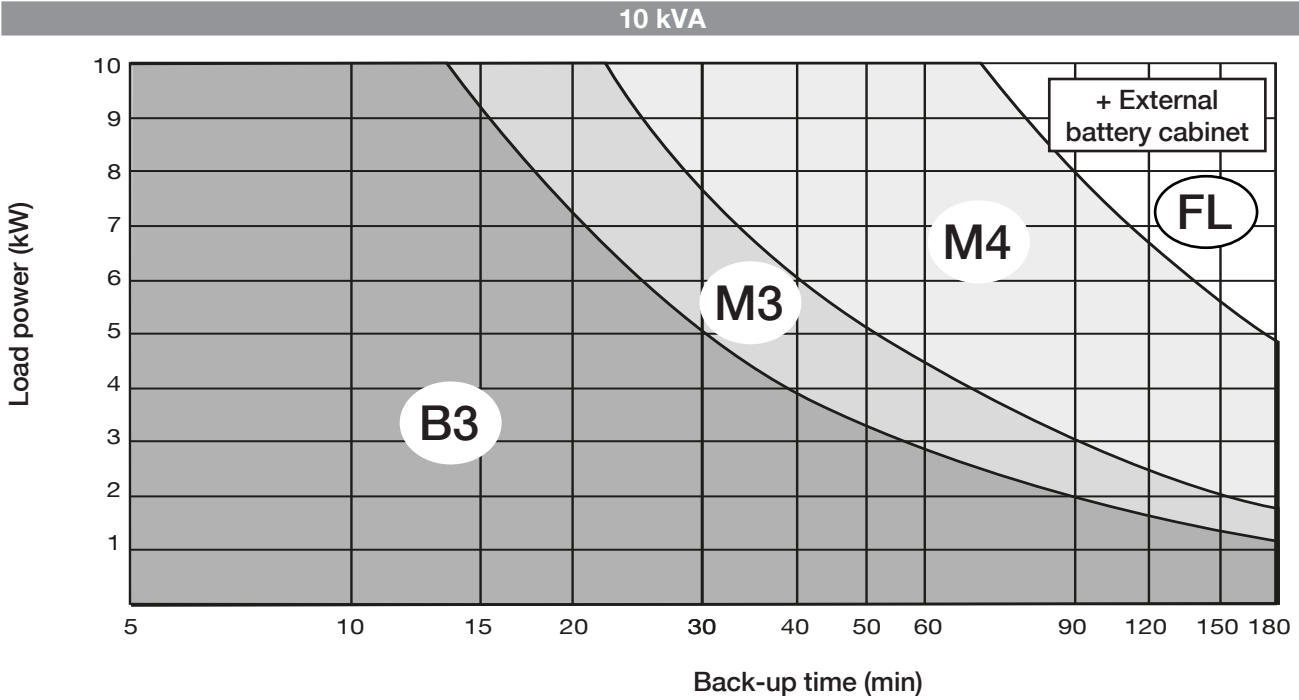

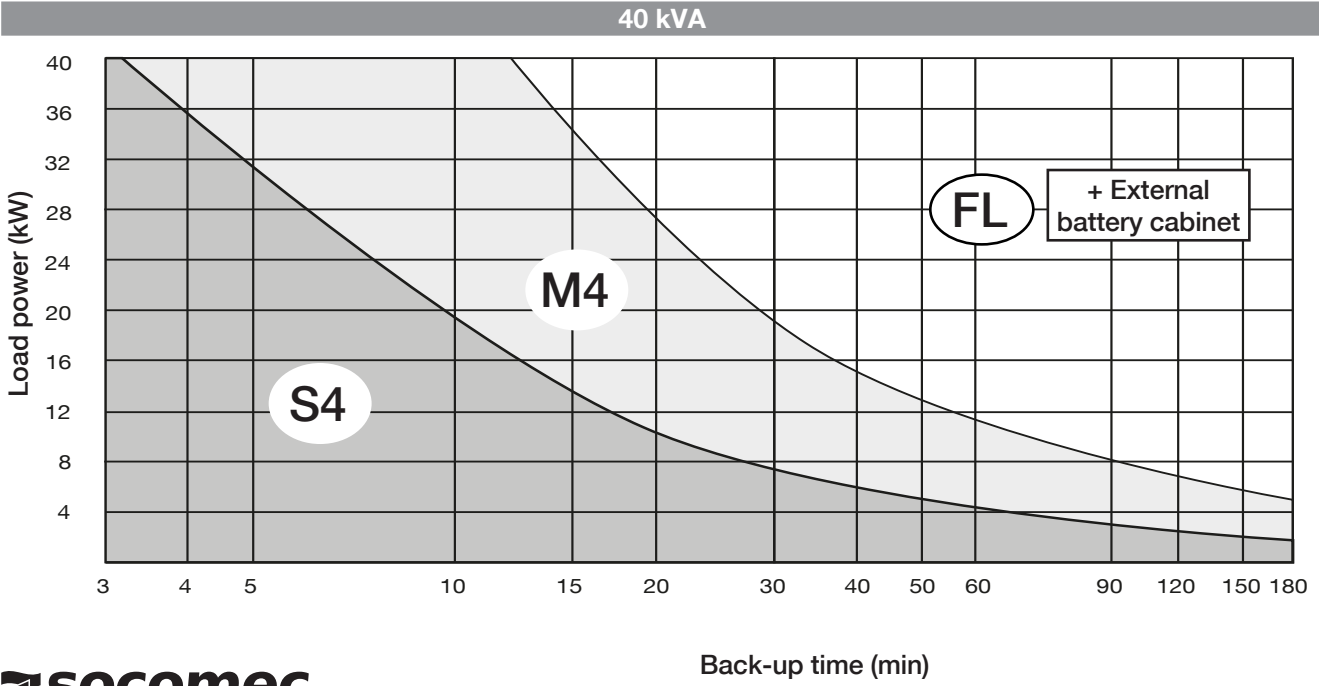
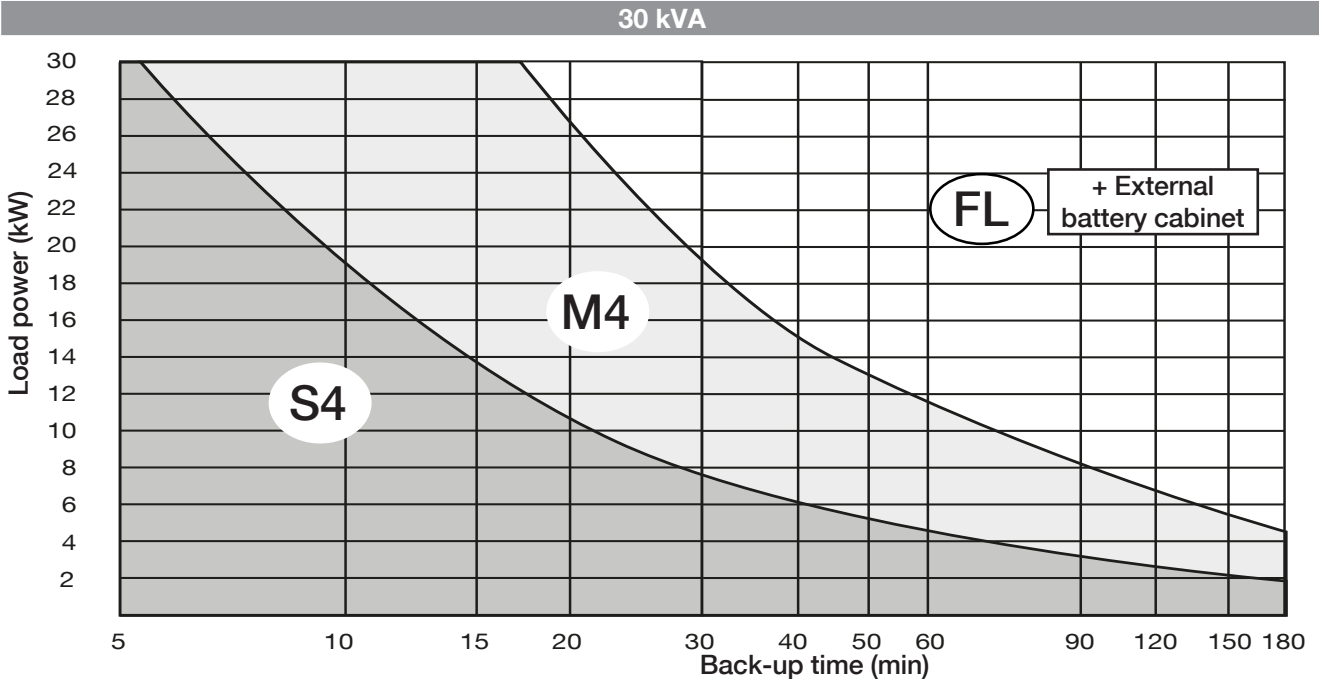
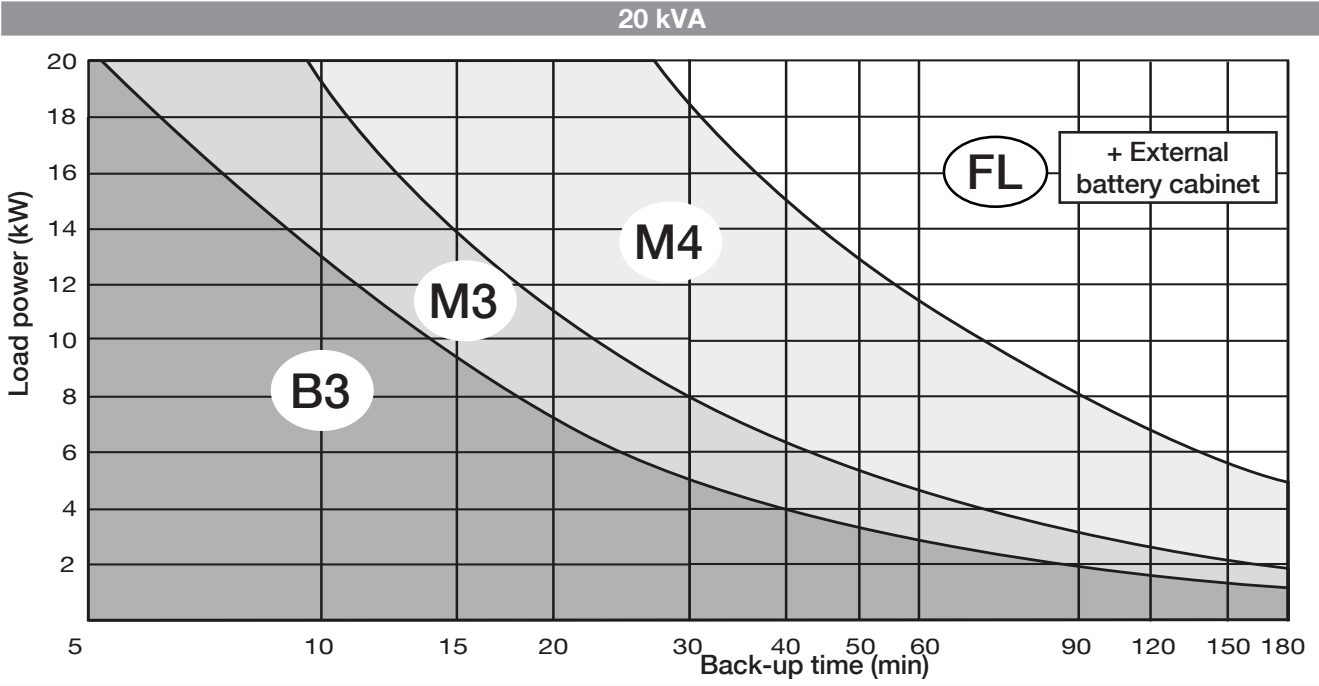

3. STANDARD FEATURES AND OPTIONS

Availability	
●	Factory-installed option
○	Available as option (installation on site)
STD	Standard feature

Features	MASTERYS BC+					Notes
	B3 M3	S4 M4		FL		
	10-15-20 kVA	10-15-20 kVA	30-40 kVA	10-15-20 kVA	30-40 kVA	
Battery Option						
Additional charger		●○	●○	●○	●○	
Communication Option						
Standard web pages	STD					
ACS card <i>(Automatic Cross Synchronisation)</i>		●○	●○	●○	●○	
ADC+SL card <i>(Advanced Dry Contact + Serial Link)</i>	○	○	○	○	○	
External temperature sensor	○	○	○	○	○	⚠️ ⓘ ADC+SL card
Remote touchscreen display	○	○	○	○	○	⚠️ ⓘ ADC+SL card
BACnet/IP interface card	○	○	○	○	○	
Modbus TCP interface card	○	○	○	○	○	
Net Vision card <i>(professional WEB/SNMP interface for UPS monitoring)</i>	○	○	○	○	○	
EMD <i>(Environmental Monitoring Device: temperature, humidity, 2 dry contacts)</i>	○	○	○	○	○	⚠️ ⓘ Net Vision card
Electrical Option						
Parallel card	●○	●○	●○	●○	●○	
External maintenance bypass	○	○	○	○	○	
External maintenance bypass width adapter kit				○	○	
Kit for TN-C / Neutral-Ground connection	○	○	○	○	○	
Internal Backfeed isolation device	●	●	●	●	●	
Kit For Common Mains	STD (3/3)	STD (3/3)	○	STD (3/3)	○	
Kit For Separate Mains	STD (3/1) ● (3/3)	STD (3/1) ● (3/3)	STD	STD (3/1) ● (3/3)	STD	
Mechanical Option						
Ramp for unloading UPS	○	○	○			
Kit for Front and Lateral Cover		○	○			
Kit for IP21	○	○	○			
Kit for Free Standing	<i>(Tower Mounted)</i>			○	○	
Kit for Top Mounted width adaptation	<i>(Socomec Battery Cabinet)</i>			○	○	
	<i>(Non-Socomec Battery Cabinet)</i>			○	○	

ⓘ Required option

⊘ Incompatible option

4. SPECIFICATIONS BC+ 10-20 KVA COMPACT



4.1 INSTALLATION PARAMETERS

Installation parameters								
Rated power (kVA)		10	15	20	10	15	20	
Phase in/out		3/1			3/3			
Active power	kW	10	15	20	10	15	20	
Rated/maximum rectifier input current (EN 62040-3)	A	16/21	23/30	31/39	16/21	23/30	31/39	
Rated bypass input current	A	44	65	87	15	22	29	
Inverter output current @ 230 V	A	44	65	87	15	22	29	
Maximum air flow	m ³ /h	408	816		408	816		
Sound level	dBA	48	50		48	50		
Power Dissipation in nominal conditions ⁽¹⁾	W	604	841	1164	593	825	1142	
	kcal/h	517	720	996	507	706	977	
	BTU/h	2060	2869	3971	2023	2814	3895	
Power Dissipation (max) in worst conditions ⁽²⁾	W	684	900	1253	672	883	1230	
	kcal/h	585	770	1072	575	755	1052	
	BTU/h	2333	3070	4274	2292	3012	4196	
Dimensions (with standard back-up time)	Width	mm	370					
	Depth	mm	770					
	Height	mm	1190/1375					
Single unit clearances	Operational	mm	Rear ≥ 200					
	Maintenance	mm	Front ≥ 1500; Top ≥ 800					
Weight, without batteries	kg	95	104	104	93	93	93	
Weight, with batteries	kg	152/290	160/299	225/299	138/286	153/288	198/288	

1) Considering nominal input current (400 V, battery charged) and rated output active power.

2) Considering maximum input current (low input voltage, battery recharged) and rated output active power.

4.2 ELECTRICAL CHARACTERISTICS

Electrical characteristics - Input							
Rated power (kVA)		10	15	20	10	15	20
Phase in/out		3/1			3/3		
Rated mains supply voltage		400 V 3ph + N					
Voltage tolerance		3Ph+N 400 V -15% +20% (up to -40% @70% of nominal load)					
Rated frequency		50/60 Hz (selectable)					
Frequency tolerance		40-70 Hz					
Power factor (input at full load and rated voltage)		≥ 0.99					
Total harmonic distortion (THDi) ⁽³⁾		≤ 3%					
Max inrush current at start-up		< I _n (no overcurrent)					

3) measured with the UPS supplied with a voltage source of negligible distortion (input source THD_v ≤ 1% - 50Hz).

Electrical characteristics - Bypass						
Rated power (kVA)	10	15	20	10	15	20
Phase in/out	3/1			3/3		
Bypass frequency variation speed	1 Hz/s (settable up to 3 Hz/s)					
Bypass rated voltage	Nominal output voltage $\pm 15\%$					
Bypass rated frequency	50/60 Hz (selectable)					
Bypass frequency tolerance	$\pm 2\%$ (configurable from 1% to 8%)					

Electrical characteristics - Inverter							
Rated power (kVA)	10	15	20	10	15	20	
Phase in/out	3/1			3/3			
Rated output voltage (selectable)	220/230/240 V			380/400/415 V			
Output voltage tolerance	Static: $\pm 1\%$ Dynamic: VFI-SS-111						
Rated output frequency	50/60 Hz (selectable)						
Output frequency tolerance	$\pm 0.01\%$ (on mains power failure)						
Load crest factor	$\geq 2.7:1$						
Voltage harmonic distortion	$< 1\%$ with linear load						
Overload tolerated by the inverter	10 min (kW)	12.5	18.8	25	12.5	18.8	25
	1 min (kW)	15	22.5	30	15	22.5	30

Electrical characteristics - Efficiency						
Rated power (kVA)	10	15	20	10	15	20
Phase in/out	3/1			3/3		
Double conversion efficiency (normal mode) - full load	Up to 95%					
Efficiency in Eco-Mode	98%					

Electrical characteristics - Environment						
Rated power (kVA)	10	15	20	10	15	20
Phase in/out	3/1			3/3		
Storage temperatures	-5 to +50 °C (15 to 25 °C for better battery life)					
Working temperature	0 to +35 °C (15 to 25 °C for better battery life) Max +50 °C @ 40% Sn for a limited time					
Maximum relative humidity (non-condensing)	95%					
Maximum altitude without derating	1000 m (3300 ft)					
Degree of protection	IP20 (IP21 as option)					
Portability	ASTM D999-08, ASTM D-880, AFNOR NF H 00-042					
Colour	RAL 7016 front E150HVF					

Electrical characteristics - Battery								
Rated power (kVA)	10	15	20	10	15	20	30	40
Phase in/out	3/1			3/3				
Standard max. current	A	4						
Battery connection in parallel configuration	UPS work with distributed battery							

4.3 RECOMMENDED PROTECTIONS

RECOMMENDED PROTECTION DEVICES - Rectifier ⁽¹⁾						
Rated power (kVA)	10	15	20	10	15	20
Phase in/out	3/1			3/3		
C curve circuit breaker (A)	25	32	40	25	32	40
gG fuse (A)	25	32	40	25	32	40

RECOMMENDED PROTECTION DEVICES - General bypass ⁽¹⁾						
Rated power (kVA)	10	15	20	10	15	20
Phase in/out	3/1			3/3		
Max I ² t supported by the bypass (A ² s)	38920			4325		
Max I _{pk} supported by the Bypass (A)	2790			930		
C curve circuit breaker (A)	80	100	125	25	32	40
gG fuse (A)	63/80	80/100	100/125	20/25	25/32	32/40

RECOMMENDED PROTECTION DEVICES - Input residual current circuit breaker ⁽²⁾						
Rated power (kVA)	10	15	20	10	15	20
Phase in/out	3/1			3/3		
Input residual current circuit breaker	0.5 A Selective					

RECOMMENDED PROTECTION DEVICES - Output ⁽³⁾							
Rated power (kVA)	10	15	20	10	15	20	
Phase in/out	3/1			3/3			
Short-circuit inverter current (A) (when AUX MAINS is not present)	0 to 40 ms	120	180	240	40	60	80
	40 to 100 ms	97	146	195	32	48	65
C curve circuit breaker ⁽³⁾ (A)	8	10	16	3	4	6	
B curve circuit breaker ⁽³⁾ (A)	16	25	32	6	8	10	

CABLES - Maximum cable section						
Rated power (kVA)	10	15	20	10	15	20
Phase in/out	3/1			3/3		
Rectifier terminals	25 mm ²					
Bypass terminals	25 mm ²					
Output terminals	25 mm ²					

(1) Rectifier protection should only be considered in the event of separate inputs. The bypass protection is given by recommendation. When the bypass and rectifier inputs are combined (common input), the general input protection rating must be whichever is the highest (bypass or rectifier).

(2) Must be selective with residual current circuit breakers downstream of the UPS connected to the UPS output. If the bypass network is separate from the rectifier circuit, or in the event of parallel UPS configurations, use a single residual current circuit breaker upstream of the UPS.

(3) Selectivity of distribution after the UPS with inverter short-circuit current (short-circuit with AUX MAINS not present). The rating of the protection can be increased by "n" times downstream a parallel UPS system, with "n" equal to the number of parallel modules.

5. SPECIFICATIONS1 BC+ 10-40 KVA



5.1 INSTALLATION PARAMETERS

Installation parameters										
Rated power (kVA)		10	15	20	10	15	20	30	40	
Phase in/out		3/1			3/3					
Active power	kW	10	15	20	10	15	20	30	40	
Rated/maximum rectifier input current (EN 62040-3)	A	15/22	23/30	31/39	15/22	23/30	31/39	46/55	62/73	
Rated bypass input current	A	48	72	96	16	24	32	48	64	
Inverter output current @ 230 V	A	43	65	87	14	22	29	43	58	
Maximum air flow	m ³ /h	240							360	
Sound level	dBA	50							58	
Power Dissipation in nominal conditions ⁽¹⁾	W	500	770	1050	500	770	1050	1600	2330	
	kcal/h	430	662	903	430	662	903	1427	2003	
	BTU/h	1706	2627	3583	1706	2627	3583	5664	7950	
Power Dissipation (max) in worst conditions ⁽²⁾	W	610	890	1220	610	890	1220	1780	2780	
	kcal/h	524	765	1049	524	765	1049	1530	2390	
	BTU/h	2081	3037	4163	2081	3037	4163	6074	9485	
Dimensions (with standard back-up time)	Width	mm 444								
	Depth	mm 800								
	Height	mm 1400						mm 800 / 1400		
Single unit Clearances	Operational	mm Rear ≥ 200; Lateral 0								
	Maintenance	mm Front ≥ 1500; Top ≥ 800								
Weight, with batteries	kg	430 / 624						333 / 624		339 / 630

1) Considering nominal input current (400 V, battery charged) and rated output active power.

2) Considering maximum input current (low input voltage) and rated output active power.

5.2 ELECTRICAL CHARACTERISTICS

Electrical characteristics - Input										
Rated power (kVA)		10	15	20	10	15	20	30	40	
Phase in/out		3/1			3/3					
Rated mains supply voltage		400 V 3ph + N								
Voltage tolerance		3Ph+N 400 V -15% +20% (up to -40% @70% of nominal load)								
Rated frequency 50/60 Hz = nominal frequency		from 40 Hz to 70 Hz								
Frequency tolerance		±10%								
Power factor (input at full load and rated voltage)		≥ 0.99								
Total harmonic distortion (THDi)		≤ 4%	≤ 3%				≤ 2.5%	≤ 2%		
Max inrush current at start-up		< In (no overcurrent)								
Power walk-in (from battery to normal mode)		fixed delay of 15 s in switching								

Electrical characteristics - Bypass									
Rated power (kVA)	10	15	20	10	15	20	30	40	
Phase in/out	3/1			3/3					
Bypass frequency variation speed	1 Hz/s (settable up to 6 Hz/s)								
Bypass rated voltage	Nominal output voltage $\pm 15\%$								
Bypass rated frequency	50/60 Hz (selectable)								
Bypass frequency tolerance	$\pm 8\%$ in operation with generator								

Electrical characteristics - Inverter									
Rated power (kVA)	10	15	20	10	15	20	30	40	
Phase in/out	3/1			3/3					
Rated output voltage phase neutral (selectable)	208/220/230/240 V			208/220/230/240 V					
Output voltage tolerance	Static: $\pm 1\%$ Dynamic: VFI-SS-11								
Rated output frequency	50/60 Hz (selectable)								
Output frequency tolerance	$\pm 0.01\%$ (on mains power failure)								
Load crest factor	≥ 2.7								
Voltage harmonic distortion	$\pm 1\%$ with linear load								
Overload tolerated by the inverter kW	10 min	12.5	18.7	25	12.5	18.7	25	37.5	56.2
	1 min	15	22.5	30	15	22.5	30	45	60

Electrical characteristics - Efficiency									
Rated power (kVA)	10	15	20	10	15	20	30	40	
Phase in/out	3/1			3/3					
Double conversion efficiency (normal mode) - full load	Up to 95%								
Efficiency in Eco-Mode	99%								

Electrical characteristics - Environment									
Rated power (kVA)	10	15	20	10	15	20	30	40	
Phase in/out	3/1			3/3					
Storage temperatures	-5 to +50 °C (15 to 25 °C for better battery life)								
Working temperature	0 to +35 °C ⁽¹⁾ (15 to 25 °C for better battery life) Max +45 °C @ 70% Sn for a limited time								
Maximum relative humidity (non-condensing)	95%								
Maximum altitude without derating	1000 m (3300 ft)								
Degree of protection	IP20 (IP21 as option)								
Portability	ASTM D999-08, ASTM D-880, AFNOR NF H 00-042								
Colour	RAL 7016 front E150HVF								

Electrical characteristics - Battery									
Rated power (kVA)	10	15	20	10	15	20	30	40	
Phase in/out	3/1			3/3					
Standard max. current	A	5							
Battery connection in parallel configuration	UPS work with distributed battery								

(1) Condition apply.

5.3 RECOMMENDED PROTECTIONS

RECOMMENDED PROTECTION DEVICES - Rectifier ⁽¹⁾								
Rated power (kVA)	10	15	20	10	15	20	30	40
Phase in/out	3/1			3/3				
C curve circuit breaker (A)	25	32	40	25	32	40	63	80
gG fuse (A)	25	32	40	25	32	40	63	80

RECOMMENDED PROTECTION DEVICES - General bypass ⁽¹⁾								
Rated power (kVA)	10	15	20	10	15	20	30	40
Phase in/out	3/1			3/3				
Max I ² t supported by the bypass (A ² s)	45000			8000			15000	
Max I _{pk} supported by the Bypass	2120			1200			1700	
C curve circuit breaker (A)	63	100	125	25	32	40	63	80
gG fuse (A)	63	100	125	25	32	40	63	80

RECOMMENDED PROTECTION DEVICES - Input residual current circuit breaker ⁽²⁾								
Rated power (kVA)	10	15	20	10	15	20	30	40
Phase in/out	3/1			3/3				
Input residual current circuit breaker	0.5 A Selective							

RECOMMENDED PROTECTION DEVICES - Output ⁽³⁾									
Rated power (kVA)	10	15	20	10	15	20	30	40	
Phase in/out	3/1			3/3					
Short-circuit inverter current (A) (when AUX MAINS is not present)	0 to 40 ms	120	177	237	40	59	79	117	156
	40 to 100 ms	99	147	198	33	49	66	98	130
C curve circuit breaker ⁽³⁾ (A)	≤ 8	≤ 10	≤ 16	≤ 3	≤ 4	≤ 6	≤ 8	≤ 10	
B curve circuit breaker ⁽³⁾ (A)	≤ 16	≤ 25	≤ 32	≤ 6	≤ 8	≤ 10	≤ 16	≤ 20	

CABLES - Maximum cable section								
Rated power (kVA)	10	15	20	10	15	20	30	40
Phase in/out	3/1			3/3				
Rectifier terminals	25	25	25	25	25	25	50	50
Bypass terminals	50	50	50	25	25	25	50	50
Output terminals	50	50	50	25	25	25	50	50

- (1) Rectifier protection should only be considered in the event of separate inputs. The bypass protection is given by recommendation. When the bypass and rectifier inputs are combined (common input), the general input protection rating must be whichever is the highest (bypass or rectifier).
- (2) Must be selective with residual current circuit breakers downstream of the UPS connected to the UPS output. If the bypass network is separate from the rectifier circuit, or in the event of parallel UPS configurations, use a single residual current circuit breaker upstream of the UPS.
- (3) Selectivity of distribution after the UPS with inverter short-circuit current (short-circuit with AUX MAINS not present). The rating of the protection can be increased by "n" times downstream a parallel UPS system, with "n" equal to the number of parallel units.

6. SPECIFICATIONS BC+ FLEX 10-40 KVA



6.1 INSTALLATION PARAMETERS

Installation parameters										
Rated power (kVA)		10	15	20	10	15	20	30	40	
Phase in/out		3/1			3/3					
Active power	kW	10	15	20	10	15	20	30	40	
Rated/maximum rectifier input current (EN 62040-3)	A	15/22	23/30	31/39	15/22	23/30	31/39	46/55	62/73	
Rated bypass input current	A	48	72	96	16	24	32	48	64	
Inverter output current @ 230 V	A	43	65	87	14	22	29	43	58	
Maximum air flow	m ³ /h	240							360	
Sound level	dBA	50							58	
Power Dissipation in nominal conditions ⁽¹⁾	W	500	770	1050	500	770	1050	1600	2100	
	kcal/h	430	662	903	430	662	903	1427	2003	
	BTU/h	1706	2627	3583	1706	2627	3583	5664	7950	
Power Dissipation (max) in worst conditions ⁽²⁾	W	610	890	1220	610	890	1220	1780	2780	
	kcal/h	524	765	1049	524	765	1049	1530	2390	
	BTU/h	2081	3037	4163	2081	3037	4163	6074	9485	
Dimensions (with standard back-up time)	Width	mm	442							
	Depth	mm	830							
	Height	mm	305							
Single unit Clearances	Operational	mm	Rear ≥ 200; Lateral 0							
	Maintenance	mm	Front ≥ 1500 Top ≥ 800							
Weight, without batteries	kg	71							77	

1) Considering nominal input current (400 V, battery charged) and rated output active power.

2) Considering maximum input current (low input voltage) and rated output active power.

6.2 ELECTRICAL CHARACTERISTICS

Electrical characteristics - Input										
Rated power (kVA)		10	15	20	10	15	20	30	40	
Phase in/out		3/1			3/3					
Rated mains supply voltage		400 V 3ph + N								
Voltage tolerance		3Ph+N 400 V -15% +20% (up to -40% @70% of nominal load)								
Rated frequency 50/60 Hz = nominal frequency		from 40 Hz to 70 Hz								
Frequency tolerance		±10%								
Power factor (input at full load and rated voltage)		≥ 0.99								
Total harmonic distortion (THDi)		≤ 4%	≤ 3%				≤ 2.5%	≤ 2%		
Max inrush current at start-up		< I _n (no overcurrent)								
Power walk-in(from battery to normal mode)		4 seconds (settable parameters)								

Electrical characteristics - Bypass									
Rated power (kVA)	10	15	20	10	15	20	30	40	
Phase in/out	3/1			3/3					
Bypass frequency variation speed	1 Hz/s (settable up to 3 Hz/s)								
Bypass rated voltage	Nominal output voltage $\pm 15\%$								
Bypass rated frequency	50/60 Hz (selectable)								
Bypass frequency tolerance	$\pm 8\%$ in operation with generator								

Electrical characteristics - Inverter									
Rated power (kVA)	10	15	20	10	15	20	30	40	
Phase in/out	3/1			3/3					
Rated output voltage (selectable)	208/220/230/240 V			208/220/230/240 V					
Output voltage tolerance	Static: $\pm 1\%$ Dynamic: VFI-SS-11								
Rated output frequency	50/60 Hz (selectable)								
Output frequency tolerance	$\pm 0.01\%$ (on mains power failure)								
Load crest factor	≥ 2.7								
Voltage harmonic distortion	< 1% with linear load								
Overload tolerated by the inverter kW	10 min	12.5	18.7	25	12.5	18.7	25	37.5	50
	1 min	15	22.5	30	15	22.5	30	45	60

Electrical characteristics - Efficiency									
Rated power (kVA)	10	15	20	10	15	20	30	40	
Phase in/out	3/1			3/3					
Double conversion efficiency (normal mode) - full load	Up to 95%								
Efficiency in Eco-Mode	99%								

Electrical characteristics - Environment									
Rated power (kVA)	10	15	20	10	15	20	30	40	
Phase in/out	3/1			3/3					
Storage temperatures	-5 to +50 °C (15 to 25 °C for better battery life)								
Working temperature	0 to +35 °C ⁽¹⁾ (15 to 25 °C for better battery life) Max +45°C @ 70% Sn for a limited time								
Maximum relative humidity (non-condensing)	95%								
Maximum altitude without derating	1000 m (3300 ft)								
Degree of protection	IP20 (IP21 as option)								
Portability	ASTM D999-08, ASTM D-880, AFNOR NF H 00-042								
Colour	RAL 7016 front E150HVF								

Electrical characteristics - Battery									
Rated power (kVA)	10	15	20	10	15	20	30	40	
Phase in/out	3/1			3/3					
Standard max. current	A	5							
Battery connection in parallel configuration	UPS work with distributed battery								

(1) Condition apply.

6.3 RECOMMENDED PROTECTIONS

RECOMMENDED PROTECTION DEVICES - Rectifier ⁽¹⁾								
Rated power (kVA)	10	15	20	10	15	20	30	40
Phase in/out	3/1			3/3				
C curve circuit breaker (A)	25	32	40	25	32	40	63	80
gG fuse (A)	25	32	40	25	32	40	63	80

RECOMMENDED PROTECTION DEVICES - General bypass ⁽¹⁾								
Rated power (kVA)	10	15	20	10	15	20	30	40
Phase in/out	3/1			3/3				
Max I ² t supported by the bypass (A ² s)	45000			8000		15000		
Max I _{pk} supported by the Bypass	2120			1200		1700		
C curve circuit breaker (A)	63	100	125	25	32	40	63	80
gG fuse (A)	63	100	125	25	32	40	63	80

RECOMMENDED PROTECTION DEVICES - Input residual current circuit breaker ⁽²⁾								
Rated power (kVA)	10	15	20	10	15	20	30	40
Phase in/out	3/1			3/3				
Input residual current circuit breaker	0.5 A Selective							

RECOMMENDED PROTECTION DEVICES - Output ⁽³⁾									
Rated power (kVA)	10	15	20	10	15	20	30	40	
Phase in/out	3/1			3/3					
Short-circuit inverter current (A) (when AUX MAINS is not present)	0 to 40 ms	120	177	237	40	59	79	117	156
	40 to 100 ms	99	147	198	33	49	66	98	130
C curve circuit breaker ⁽³⁾ (A)	≤ 8	≤ 10	≤ 16	≤ 3	≤ 4	≤ 6	≤ 8	≤ 10	
B curve circuit breaker ⁽³⁾ (A)	≤ 16	≤ 25	≤ 32	≤ 6	≤ 8	≤ 10	≤ 16	≤ 20	

CABLES - Maximum cable section								
Rated power (kVA)	10	15	20	10	15	20	30	40
Phase in/out	3/1			3/3				
Rectifier terminals	25	25	25	25	25	25	50	50
Bypass terminals	50	50	50	25	25	25	50	50
Battery terminals	25	25	25	25	25	25	50	50
Output terminals	50	50	50	25	25	25	50	50

(1) Rectifier protection should only be considered in the event of separate inputs. The bypass protection is given by recommendation. When the bypass and rectifier inputs are combined (common input), the general input protection rating must be whichever is the highest (bypass or rectifier).

(2) Must be selective with residual current circuit breakers downstream of the UPS connected to the UPS output. If the bypass network is separate from the rectifier circuit, or in the event of parallel UPS configurations, use a single residual current circuit breaker upstream of the UPS.

(3) Selectivity of distribution after the UPS with inverter short-circuit current (short-circuit with AUX MAINS not present). The rating of the protection can be increased by "n" times downstream a parallel UPS system, with "n" equal to the number of parallel modules.

7. FLEX UPS

Choose the perfect configuration at the last minute - on-site - with Flex-UPS, the first device that adapts to the environment rather than requiring the environment to adapt to the device. Three positioning choices are available depending upon the technical room space and the type of battery frame. Flex-UPS delivers a unique freedom to get building UPS and battery solution.

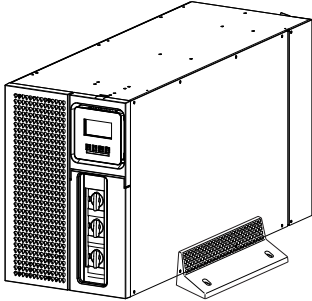

Free standing configuration:
the unit can be installed in vertical position and kept in place with lateral support.

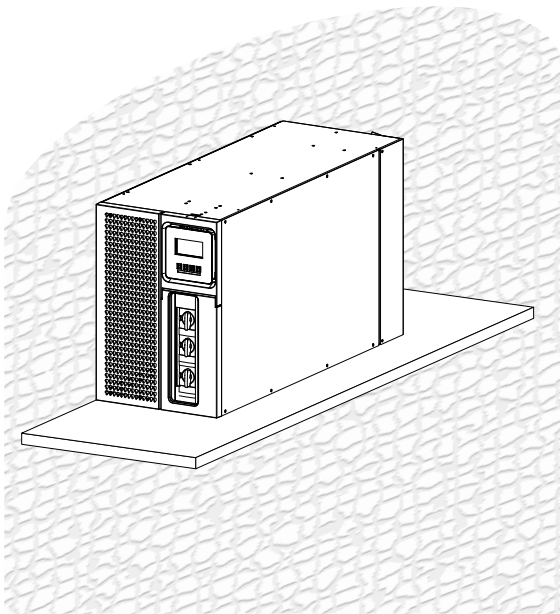

Wall mounted configuration:
Masterys BC+ Flex can be installed vertically or horizontally on a shelf; the display can be rotated accordingly

Solution compatible with existing shelves

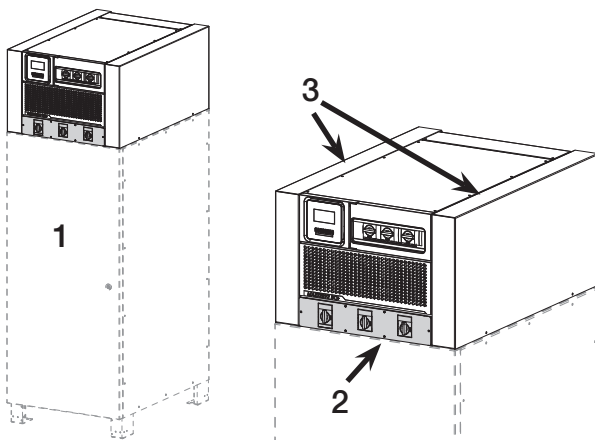

Installation on top of battery cabinets:

The UPS can be installed on top of battery cabinet (Socomec or not) selecting the compatible kit.

The UPS is supplied as stand alone, according to the needs you can add:

- 1: battery cabinets
- 2: external manual bypass
- 3: lateral covers

8. REFERENCE STANDARDS AND DIRECTIVES

8.1 OVERVIEW

The construction of the equipment and choice of materials and components comply with all laws, decrees, directives and standards currently in force.

In particular, the equipment is fully compliant with all European Directives concerning CE marking.

LVD 2014/35/EU

Directive of the European Parliament and of the council of 26 February 2014 on the harmonisation of the laws of the Member States relating to the making available on the market of electrical equipment designed for use within certain voltage limits.

EMC 2014/30/EU

Directive of the European Parliament and of the council of 26 February 2014 on the harmonisation of the laws of the Member States relating to electromagnetic compatibility.

RoHS 2011/65/EU

Directive 2011/65 of the European parliament and of the council of 8 June 2011 on the restriction of the use of certain hazardous substances in electrical and electronic equipment

8.2 STANDARDS

8.2.1 SAFETY

EN 62040-1 Uninterruptible Power System (UPS) - Part 1: General and safety requirements

IEC 62040-1 Uninterruptible Power System (UPS) - Part 1: Safety requirements (CB scheme by TÜV)

8.2.2 ELECTROMAGNETIC COMPATIBILITY

EN 62040-2 Uninterruptible Power System (UPS) - Part 2: Electromagnetic compatibility (EMC) requirements (tested and verified by third party)

IEC 62040-2 Uninterruptible Power System (UPS) - Part 2: Electromagnetic compatibility (EMC) requirements

8.2.3 TEST AND PERFORMANCE

EN 62040-3 Uninterruptible Power System (UPS) - Part 3: Method of specifying the performance and test requirements

8.2.4 ENVIRONMENTAL

IEC 62040-4 Uninterruptible Power System (UPS) - Part 4: Environmental aspects - Requirements and reporting

8.3 SYSTEM AND INSTALLATION GUIDELINES

When carrying out electrical installation, all the above standards must be observed. All national and international standards (e.g IEC60364) applicable to the specific electrical installation including batteries must be observed. For further information refer to 'Technical specifications' chapter in the user manual.



ELITE UPS: a mark of efficiency

Socomec, as CEMEP UPS manufacturer member, has signed a Code of Conduct put forward by the Joint Research Centre of the European Commission (JRC), to ensure the protection of critical applications and processes ensuring 24/7 continuous high quality supply. The JRC commits to mitigating energy losses and gas emissions caused by UPS equipment, therefore maximising UPS efficiency.

